



**Custom Made OVERHEADDOORS,
the quality solution for every façade**

Custom Made

When searching for the right overhead door, safety, durability, customisation and appearance are very important. You are looking for a reliable product that will operate problem free under all conditions. A proven product that will be made according to your specification and be delivered on time.

Our overhead doors meet the most stringent European guidelines in the area of safety and durability. For more than ten years, they have been installed and appreciated throughout Europe, from Iceland to Sweden and from Switzerland to Spain. In a wide range of applications and in changing weather conditions (temperature, wind and water), the overhead doors provide reliable access through the openings in which they are installed.

We offer you an extensive range of quality overhead doors and innovative special doors. From steel and alumi-

nium, with or without windows, in almost any desired size and colour. Thanks to the many combinations that are possible, the doors can simply be integrated in both industrial and commercial buildings. They are easy to operate, are functional and improve the appearance of your premises. This brochure gives a detailed overview of our models, materials, product variants and special doors. Based on this information, you can together with your advisor, determine the specifications of your door. We also offer an appropriately priced, quality solution for your exterior door openings.

Contents

Quality guaranteed	Page	3
Pro-Line S40, if you are looking for insulation and durability	Page	4
Pro-Line A40, for individual creative freedom	Page	8
Special overhead doors for specific applications	Page	12
Guide rail systems, the silent strength	Page	16
Safety first	Page	18

Quality guaranteed

With our overhead doors, you can count on optimum safety and durability from the product, the delivery, the installation and service. We guarantee the best quality.

Flexible

Our overhead doors are constructed from various steel or aluminium sections. This allows you to specify the format, functionality and appearance you desire. Moreover, the doors can be supplied in any RAL colour. Our experienced engineers have the expertise to allow them to develop a suitable overhead door, even for your complex situation.

Durability

Of course, you want an overhead door that completely meets your wishes and will operate problem free for many years. The panels in our doors are perfectly protected against corrosion, thanks to the use of high-quality materials, which are galvanised and coated. This guarantees a long life, even when exposed to extreme weather conditions.

Certified

To guarantee the quality and safety of industrial doors, the European Commission has established (European) guidelines in the EN 13 241 1:2003 standard. All of our overhead doors meet the requirements specified in this CE NEN standard. This has been determined by the accredited Swedish research centre SP Technical Research Institute of Sweden.

Reliable

Our overhead doors are produced entirely in Europe. We have been delivering, in accordance with the agreed specifications and delivery times, quality doors from our own factories throughout Europe for more than fifteen years. We keep our quality standards high by means of product innovation and extensive internal quality control. Our products make us one of the leading door companies in Europe.

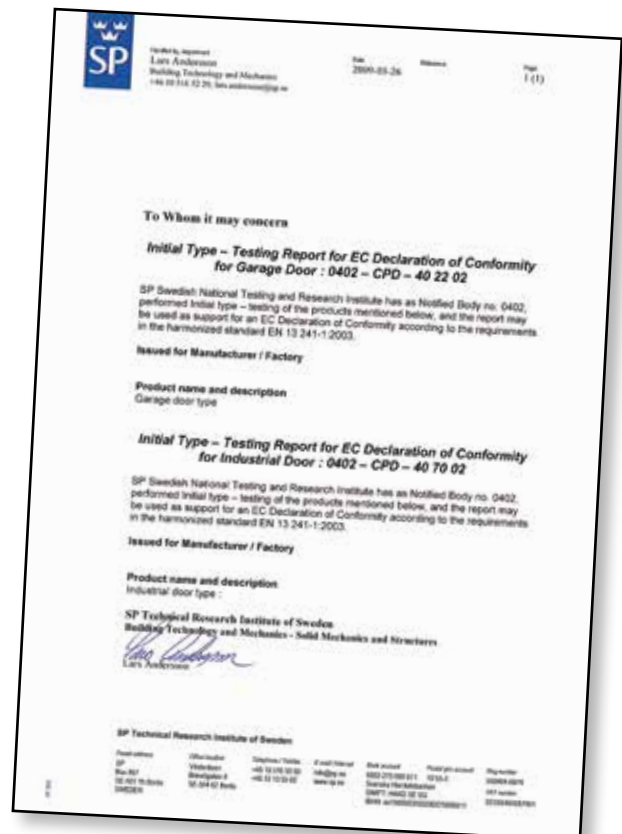



Pro-Line S40, if you are looking for insulation and durability

**Our most widely used industrial overhead door is our Pro-Line S40 model.
A universal steel door that is made to measure (up to 12 metres wide).**



High insulation value

All of our S40 overhead doors are made of 40-millimetre thick, steel sandwich panels (sections). The male-female construction ensures that they fit together almost seamlessly. The front and back skins of the panels are made of extra thick steel. These skins are separated by a fire-retardant polyurethane (CFC free) foam core.

Long life

Thanks to the extra thick steel skin, that is galvanised and coated, the doors are optimally protected against deformation and corrosion. You are ensured that your door will have a long life.

Made to measure

Pro-Line S40 overhead doors are manufactured to the exact specified size and assembled and installed on site. If required, S40 doors can be fitted with a pass door and/or windows. The overhead door can be operated manually, semi-automatically (with a chain hoist) or fully automatically (with a motor).

General specification of the S40 models

Model	Thickness of panel	U-value	RC-value	R'w-value
S40	40 mm	0,56 W/M ² *K	1,78 m ² K/W	24 dB
Design-Line	40 mm	0,56 W/M ² *K	1,78 m ² K/W	24 dB

Standard RAL colours outer skin S40

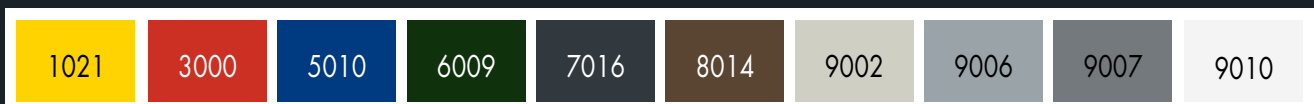

Additional standard RAL colours for the outer leaf for a small surcharge

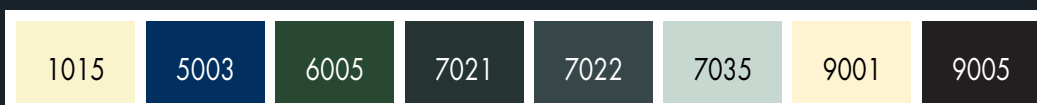

Standard RAL colours outer skin DLU (Design-Line Umbra)

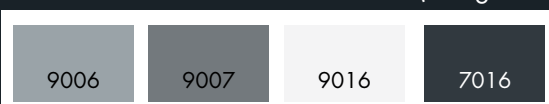

RAL-9002 is used as the standard colour of the inner skin of both models

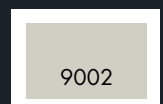

Printed colours are an indication of the real colours!



Pro-Line S40 supplied as standard with finger protection

The outer skin of our standard model is embossed and has horizontal lining, which gives it an attractive appearance. The outer skin of the panels is available in various standard colours (see Table). For an additional charge, the overhead door can be coated in any desired RAL colour. The inner skin of the door is stucco and is coated as standard in RAL 9002. This also applies to the Design Line models. All our Pro-Line S40 and Design Line models are CE approved, and so are safe to use.

Due to the special form of the panels, the standard S40 model offers improved safety. The finger protection prevents the fingers getting caught between the panels when opening and closing the door. Finger protection is obligatory (CE standard) for overhead doors up to a height of 2.50 metres (the height of the pivot point of the top section). This does not apply to higher overhead doors. But we have decided to supply the doors with finger protection, irrespective of the height of the door. After all, your safety and that of your employees is of paramount importance.

Windows for more light and an improved appearance

Do you want more light to enter the area behind the overhead door or do you want to be able to look through the door to the outside? Then it is possible to add one or more windows to the overhead door.

For the Pro-Line S40 models, you can select insulated oval or rectangular windows. If you want to increase the amount of illumination, the possibility exists to glaze the entire width of the overhead door. We do this by combining the steel S40 panels with aluminium (Pro-Line A40) window sections. This allows even more light to enter, which is a simple way of increasing the light on the work floor. Moreover, it gives your overhead door a more industrial appearance.

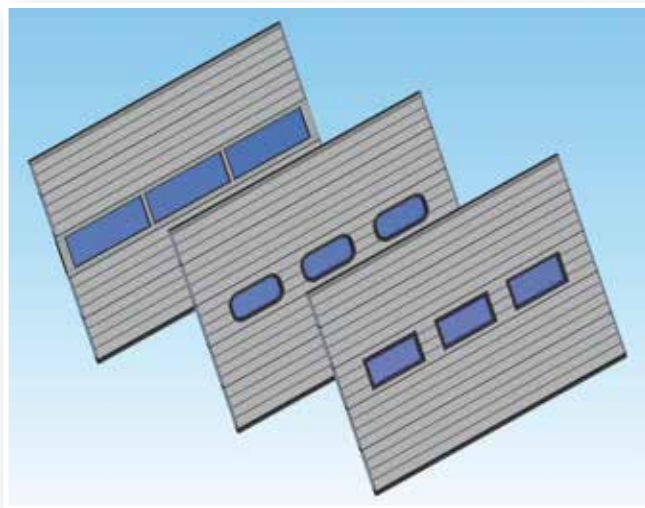

Design-Line

Are you looking for a steel overhead door with a special appearance, then our Design-Line series is for you. There are various designs for the steel skin of the panels used in this line: Umbra, Antra, Granite and Quartz.

Design-Line Umbra

The pronounced pattern of lines and embossment (microprofiling) of the Design-Line Umbra gives your industrial door a striking appearance. The Umbra is available as standard in four colours: RAL-9006, RAL-9007, RAL-9016 and RAL-7016.

Design-Line Antra

The Design-Line Antra is finished in an attractive anthracite colour and has an extraordinary texture. It gives your door a modern appearance, in perfect keeping with the latest trends and architectural styles.

Design-Line Granite

The name already says it, sturdy and strong! The high-quality surface texture combined with the dark-grey appearance make the Granite an absolute must! The Granite is an example of good taste that will add class to your home. Just like all of the panels in the Design-Line series, the Granite also meets the highest quality requirements.

Design-Line Quartz

If you're looking for a tranquil, natural appearance for your industrial door, then the Design-Line range also offers the Quartz model. The extraordinary quartz-grey surface texture of this design has a fresh and surprisingly natural appearance. You will enjoy every door in the Design-Line series problem-free for years.

Design-Line

UMBRA 9006

UMBRA 9007

UMBRA 9016

UMBRA 7016

ANTRA

GRANITE

QUARTZ



Pro-Line A40 aluminium, for individual creative freedom

The top of the line in overhead doors is our A40 model. A robust, reliable and durable aluminium overhead door with a wide range of options. Each door is designed and made completely to your individual wishes. This makes every A40 overhead door unique and also reflects the styling of your building and your corporate identity.

Flexible layout

The Pro-Line A40 overhead door is constructed from aluminium frames. Within these frames, one or more types of panel can be fitted in accordance with your wishes. Next to each other the frames form a section. The sections together form the structure of the overhead door and determine its appearance. The layout of the structure is designed for each door individually. The number of frames and sections can therefore differ per door, as can the format of both. This provides you with the optimum creative freedom and the A40 overhead doors are suitable for the widest range of architectural designs.

Individual styling

To give your overhead door an individual style, you can combine a wide range of transparent and blank panels. You can find an overview of all of the available panels in the table on Page 11. An endless number of combinations are possible. The sections of the ST40 model are as standard made of anodised aluminium (E6EV1).

Powder coating

If the sections will be supplied in a colour, then the profiles will receive a high-quality coloured powder coating. This single layer powder coating guarantees high-quality colour, gloss, hardness, durability, adhesion and coating thickness.

Durable, transparent and attractive

Aluminium overhead doors are even more durable thanks to the use of high-quality materials. By using transparent fillings in the design, the overhead door allows the maximum amount of light to enter the building. It gives the overhead door an attractive appearance and makes it extremely suitable for use where appearance is important such as in showrooms, firestations and ambulance-stations. In addition, the transparent fillings increase the amount of light that enters the building. As a result, additional artificial light is often unnecessary. This guarantees important savings.



Blank steel bottom section

The use of transparent panels gives an overhead door a certain elegance, but in practice, the bottom section of the door often gets more dirty and is more likely to get damaged. Therefore, for practical considerations, many companies choose a combination with a single matching blank steel bottom section (Pro-Line S40). The appearance of the steel bottom section is of course adapted to the style of the entire door.

Only available with finger protection

All our overhead doors are CE approved, and are safe to use. Pro-Line A40 overhead doors are supplied as standard with finger protection. The finger protection prevents the fingers getting caught between the panels when shutting the door.

Finger protection is not obligatory (CE standard) for overhead doors higher than 2.50 metres (the height of the pivot point of the top section). However, we have consciously chosen to equip all our doors with finger protection.





Pass door and operation

Pro-Line A40 doors can, if required, be fitted with a pass door. You can choose between a standard sill and a low sill. The overhead door can be supplied as a manually operated

door, with a chain hoist or with the Pro-Line© drive system.

Additional creative wishes?

In addition to all of the options mentioned, we have the knowledge and skills to meet the more complex individual wishes.

Options for the fillings in an AR overhead door

Type	Glazing	Description
Acrylic	Single pane Insulated	Transparent
Safety glass	Single pane Insulated	Transparent
Polycarbonate (impact-resistant)	Single pane Insulated	Transparent
Perforated aluminium	Single 3 mm thick	Aluminium colour
Filling	Insulated	Aluminium filling, in RAL of your choice
Specials in acrylic	All options: in single or insulated available	Opal 30% (30% light transmission) Opal 80% (80% light transmission) Pearl (transparent with air bubbles) Smoke (grey transparent)
Specials in safety glass	Single 4 mm thick Insulated	Grey smoked glass



Special overhead doors for specific applications

In addition to the Pro-Line S40 and A40 models described above, we have the knowledge and experience to develop innovative solutions for specific applications. Through the years we have developed, together with our customers, a number of special overhead doors.

These have proved themselves in practice and are now available in our standard product range. For instance, special dock doors (SD40 or SD80) for distribution centres, additionally insulated ST doors for storage areas, aluminium doors for the food and beverage industry and extra large overhead doors for, for instance, shipyards and hangars.

We can also develop a special overhead door for your individual application.

Pro-Line SD40 and SD80

Overhead doors are always used for dock levellers. The large numbers of doors (for instance in distribution centres) and their extremely frequent use, place additionally high requirements on the quality of both the materials used and the operation of the doors.

Our specially developed dock door is constructed in such a way that it can fulfil these extreme requirements. Thanks to the well-thought through construction, the door is even less sensitive to wear than a standard overhead door. Moreover, the dock door has a modular structure, so that maintenance takes less time. The technical construction of the dock door guarantees clearly lower construction and maintenance costs.

Dock doors are only available in a 'vertical lift' or 'high lift' version. They are as standard designed with a box section construction to which the springs are attached. Of course, the cables are routed inside (obligatory to conform to the CE standard).

Our SD40 and SD80 dock doors can also be adapted to your individual wishes.

Pro-Line AS40-Aluminium sandwich overhead door

Extremely stringent hygienic conditions are required in the food and beverage industry. Overhead doors must be able to be cleaned daily, without damaging the material from which they are made. AS40 doors are also well suited for other applications where the doors must be cleaned regularly.

The AS40 overhead door is specially fitted with insulating sandwich panels with an aluminium (instead of steel) inner and outer skin. Aluminium is durable and less susceptible to corrosion, also when cleaned frequently. Moreover, the material is light in weight.

The Pro-Line AS40 door is only available without finger protection. The aluminium panels have a smooth finish with embossed horizontal lining on both the inner and outer skins. They can be combined with stainless steel hardware.





Pro-Line S80, extra insulating overhead door

If it is important to maintain a stable temperature inside the building but access is still required, for instance for (cold) storage, an extra insulating overhead door can offer the solution. The S80 model is a standard ST door, with sandwich panels that are twice as thick (80 mm instead of 40 mm). Thanks to the extra thick panels, the doors have a high insulation value and save energy. Your products remain cold and your energy costs low.

The Pro-Line S80 is only available without finger protection. The standard panel is embossed on the outer skin and has horizontal lining. The inner skin is stucco and has the same horizontal lining. The inner skin is always finished in RAL-9002. The outer skin is available as standard in RAL-9002, RAL-9006 or RAL-7016.



Some characteristics of the Pro-Line S80 panels

Model	Panel thickness	U-value	RC-value	R'w-value
S80	80 mm	0,29 W/m ² K	3,46 M ² K/W	26 dB

The Pro-Line S40 XXL version

Sometimes a hall, for instance a hangar, has an extremely large entrance. A standard overhead door cannot provide a safe and high-quality seal. Moreover, the dimensions and weight of the overhead door place extremely high requirements on the materials.

Our XXL overhead door is especially constructed for applications up to a width of 12 metres (max. 12 x 6 metres to max. 9 x 8 metres). To prevent the door from sagging, the sections are made with additional reinforcement on the door leaf (CMV's).

Due to the complexity of the construction, it is necessary to perform design calculations for every XXL overhead door. Our experienced product engineers are supported in this by sophisticated software. The result is a made-to-measure, safe and durable, extra-large overhead door.

Individual applications

In this brochure, you can find several examples of customised doors for specific applications. It is our professional challenge to develop together with you a suitable overhead door for your specific situation.





Guide rail systems, the silent strength

A guide rail system is used when opening and closing an overhead door. This system consists of a set of rails, the springs and the operating equipment. The guide rail system forms the silent strength of every overhead door.

Rail set

The rail set is, just like the overhead door, always custom made. A rail set is designed and made to measure in our factory for every overhead door. The quality of the rail set determines to a large degree the life of your overhead door. Therefore, we have consciously chosen rails that are made from high-quality galvanised steel.

A permanent part of the set is the unique **Smart-Connection®** between the horizontal and vertical rails for which we have a patent. Thanks to this innovative connection, the door moves smoothly over the rails when being opened and closed. This makes the door more or less silent and less susceptible to wear.

Springs & hoisting cables

Steel lifting springs and cables are used to open the overhead door and to keep it open. The springs are of a high quality and have a long life. They are shot peened, powder coated and oiled when delivered. Special springs are available for overhead doors that are used very frequently. The hoisting cables are six times overdimensioned for additional safety.

Operating equipment

The overhead door can be operated manually, with a chain hoist or by an electric motor. We will be pleased to advise you of the possibilities and advantages of each mode of operation.

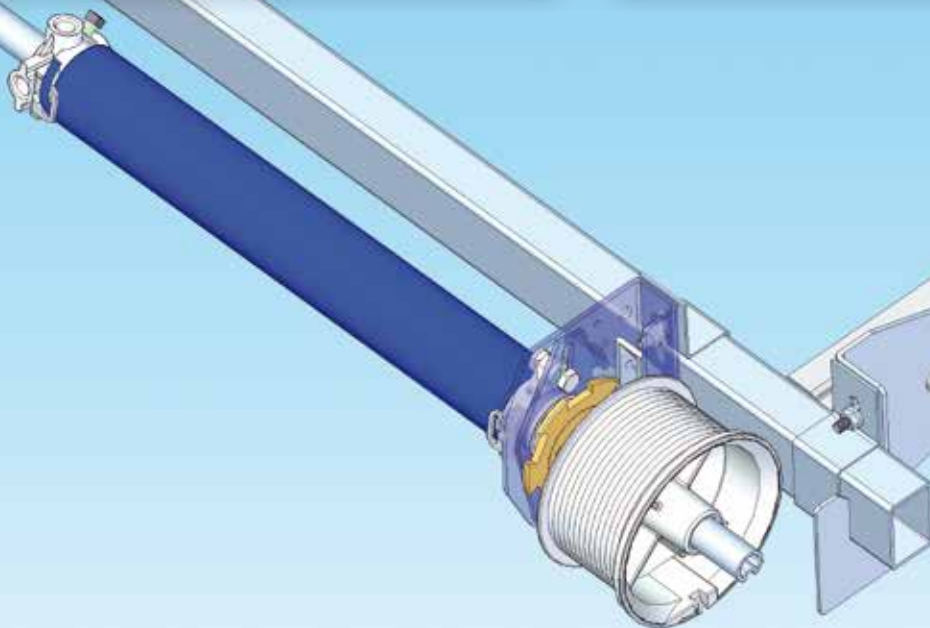
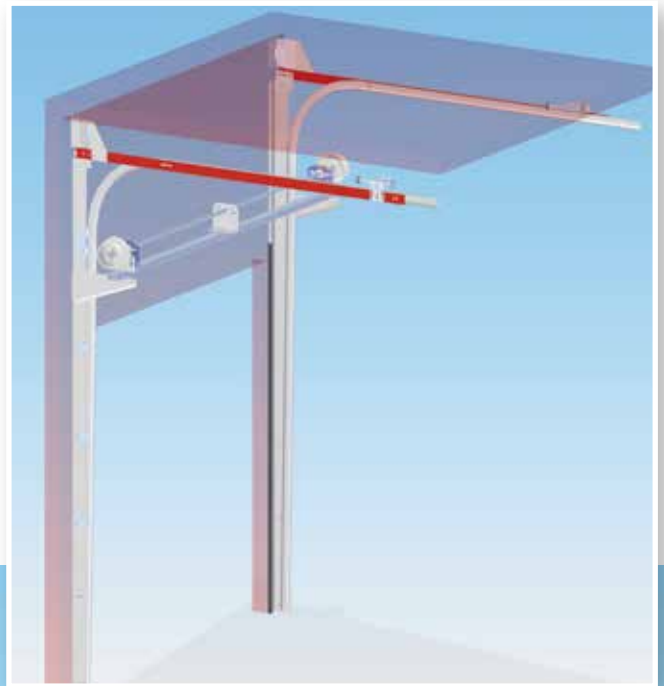



Safety first

Safety is very important for us when designing, constructing and installing our overhead doors.

Of course, our overhead doors and guide rail systems meet the applicable product standard (EN13241 1) for 'Industrial doors, commercial doors and garage doors and fences', in accordance with the Construction Products Directive (CPD) and the Machinery Directive (MD). The doors are also equipped with TÜV approved safety components: the spring break and cable break safety devices and the (switchable) slack cable safety device.

In addition to the standard (obligatory) safety devices, we also offer other supplementary safety provisions.

Spring break safety device

If a spring of the guide rail system breaks (for instance at the end of its life), it is possible for the overhead door to suddenly shut at great speed. For manually operated doors especially, this can result in dangerous situations. Therefore, these overhead doors are fitted as standard with an obligatory spring break safety device. If another mode of operation is used, the spring break safety device can be fitted as an extra option.

Cable break safety device (recommended)

In the unlikely event that one of the cables of the guide rail system breaks, an unsafe situation can develop when opening or closing the door. To reduce the risk of a cable break, we overdimension the cables six times. This reduces the probability of both cables breaking at the same time to almost zero. Although when using our cables it is not obligatory to fit a cable break safety device, we recommend that one be fitted. After all, safety really does come first.

Slack cable safety device

If the cable goes slack, for instance if when closing the door it stops moving, the slack cable safety device ensures that the motor stops. Dependent on the bottom bracket used, one or two slack cable devices are required. If the cable break device is used as a bottom bracket, then a single slack cable device is sufficient. When all other bottom brackets are used, two slack cable devices must be ordered.

Safety edge

You can also select a safety edge to be fitted on electrically operated overhead doors for additional safety. If the

door closes while someone or something is under it, the safety edge stops the door automatically.

Safety edge and light curtain

Let a safety edge or a light curtain be fitted to electrically operated overhead doors for additional safety. With the safety edge installed, when the door is closing it will stop and automatically reopen if the safety edge is touched. The light curtain secures the entire door opening. As soon as someone or something is detected in the door opening when the door is closing, the door will automatically reopen.



Finger protection

Finger protection is obligatory (CE standard) for overhead doors up to a height of 2.50 metres (the height of the pivot point of the top section). Finger protection is not obligatory for higher overhead doors, but offers extra protection.

All our Pro-Line S40 and A40 models are fitted with finger protection. The choice is yours

Summary of the safety/ security possibilities

Description	Obligatory	Recommended
Spring break safety device	For manually operated doors and doors operated by a chain hoist	Always
Cable break safety device	If the cables are less than six times overdimensioned	Always
Slack cable safety device	For electrically operated doors	Install 2 per door
Safety edge	Not obligatory	For safety and ease of use
Smart-Lock device	Not obligatory	For security and smaller doors
Finger protection	If the pivot of the top section is below 2500 mm	Always



Our overhead doors are professionally made to measure. The production processes are fully automated. Accurately programmed machines guarantee exact dimensioning and check the processes to the millimetre. Of course, we only use high-quality materials in our production process.

After all, quality and custom-made solutions are our standard.